



Digital Imaging & Metrology

CNC Video Measuring System

iNEXIV

VMA-2520





Electron gun

Designed to meet the automated metrology requirements of mechanical parts, electronic devices, dies & molds and medical devices

Metal press parts

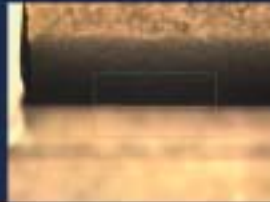

Main features

Easy and accurate measurements optimized for 3D parts

Nikon has drawn on its state-of-the-art digital technologies to produce a highly affordable automated measurement system. The iNEXIV VMA-2520's design is optimized for easy use as well as repeatable and accurate measurement of 3D parts.

Compact and lightweight

The iNEXIV VMA-2520 is a powerful bench top system designed to use minimum factory floor space. The main body has a footprint of only 565mm W x 690mm D x 740mm H (computer and controller separate) and weighs only 72kg (158.7 lb), yet it still has a 250mm x 200mm x 200mm measuring capability.

Long working distance

The newly developed optical system features a super long 73.5mm working distance for all magnifications. This allows sufficient three dimensional clearance for Z-axis measurements even at high magnification.



Digital Imaging & Metrology

iNEXIV VMA-2520

The new iNEXIV VMA-2520 has been expressly designed for three-dimensional workpieces. Though compact and lightweight in design, it provides a long 200mm Z-axis stroke and a 73.5mm working distance, enabling easy Z-axis measurement of mechanical parts, plastic injection molding parts, metal press parts, electronic devices, dies & molds and medical devices. The standard 10x zoom optics meets the industry's demanding needs for superb resolution at high magnifications while offering a wide field of view at low magnifications. Low distortion optics and high intensity white LED illumination sources improve contrast to enhance throughput. This combination assures reproducible measurements even for colorful parts.



Plastic injection molding parts

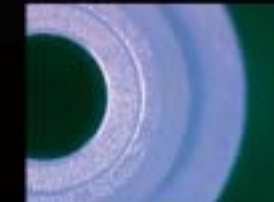

High-speed, highly-accurate Laser AF (optional)

In addition to the standard Vision AF, an optional high-speed Laser AF with a long 63mm working distance is available. It provides fast focusing and Z-axis measurements regardless of the surface shape of your workpiece.

Touch probing measurement (optional)

The iNEXIV VMA-2520 accepts the Renishaw TP20 system, making 3D parts measurement much easier.

Sophisticated VMA AutoMeasure software

This new versatile software has been developed exclusively for the VMA-2520. It provides various functions to easily conduct tasks ranging from setup, teaching programs and measurements, to evaluations.



Connector



Plastic injection molding parts



Aluminum die casting parts



Drill



Compact, lightweight design offering an extended measurement height



Compact, space-saving body weighing 72kg

The VMA-2520 features a space-saving design with a footprint of just 2000 x 1000mm (main body & PC rack space). Although the body has a compact design and a height of only 740mm (min), it is capable of achieving a long 200mm Z-axis stroke, and because its structure is composed of aluminum-alloy materials, it only weighs 72kg (158.7 lb).

Long 200mm Z-axis stroke plus 250mm x 200mm XY stroke

The VMA-2520 has a unique extendable optical head design that provides a Z-axis stroke of 200mm. Couple this with an X-Y stage travel of 250mm x 200mm and you have a system making measurements of 3D parts such as injection molding parts, metal parts, electronic devices, molds and medical devices easier to manage.



High accuracy

By employing aluminum-alloy materials in its construction, pitch and yaw deviations caused by temperature fluctuations have been minimized. This, combined with the fast, highly accurate stage controls, increases both measurement accuracy and yield.

XY MPEE1: 2+8L/1000µm
 XY MPEE2: 3+8L/1000µm
 Z MPEE1: 3+L/50µm

Easy setup

Only an IEEE1394 port and a USB2.0 port are required to connect a host computer to the iNEXIV controller. In addition, Nikon's new image processing technology eliminates the need for a frame grabber.



Table for the main body and PC rack are optional

New zooming optics make 3D parts measurements easier

Newly designed optics with an Apochromat LWD objective lens

Nikon has developed a new optical system that covers low magnifications, has a long working distance and is suitable for measuring three-dimensional parts. The Apochromat objective lens features low distortion (0.1% or less) while providing a long 73.5mm working distance throughout all magnification ranges. Moreover, improvements in the LED illumination system also increase image contrast by utilizing an Apochromatic lens to compensate for the blue wavelengths emitted from white LEDs.

10x zoom with wide field of view

The VMA-2520 comes standard with a five-step, 10x zoom optical system that provides both superb resolution at high magnification and a wide field of view at low magnification. Greater position accuracy, achieved by eliminating backlash in the zooming mechanism when using the five-step zoom range, makes it ideal for measurement applications.

Magnification on screen: 12x to 120x (with 17" monitor at SXGA resolution)

Field of view: 13.3 x 10 to 1.33 x 1mm

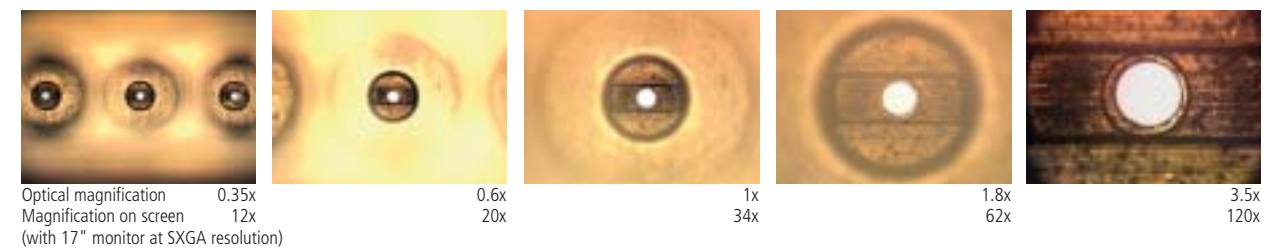

White LED illumination for fast, high-accuracy measurement



8-segment LED ring illumination

This illumination system can be controlled from eight different directions. The white LED light with an average incidence angle of 18° makes possible observations of extremely low-contrast edges which are usually invisible under episcopic illumination. It is effective for measuring molds, medical devices and other three-dimensional parts.

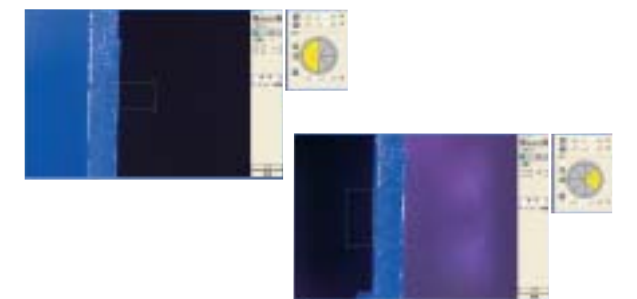

High-intensity white LED light source for all illumination systems

The VMA-2520 employs a white LED light source for episcopic illumination, diascopic illumination and 8-segment LED ring illumination. The high-intensity white LED features constant color temperature and less flicker, thus it provides stable measurement accuracy, particularly when observing color images. With the LED's quick response to lighting controls, increased measurement throughputs can be achieved.

Episcopic and diascopic illuminations

Both episcopic and diascopic illuminations employ a white LED light source that provides high-intensity closer to that of a halogen lamp. For the episcopic illumination, which previously did not use a white LED light source, the VMA-2520 employs the first flyeye integrator in a measuring system, realizing both sufficient NA and uniform illumination over a wide field of view. The diascopic illumination uses a white LED array, backlight system.

Multiple sensors for high speed and accurate height detection— Vision, Laser and Touch Probe

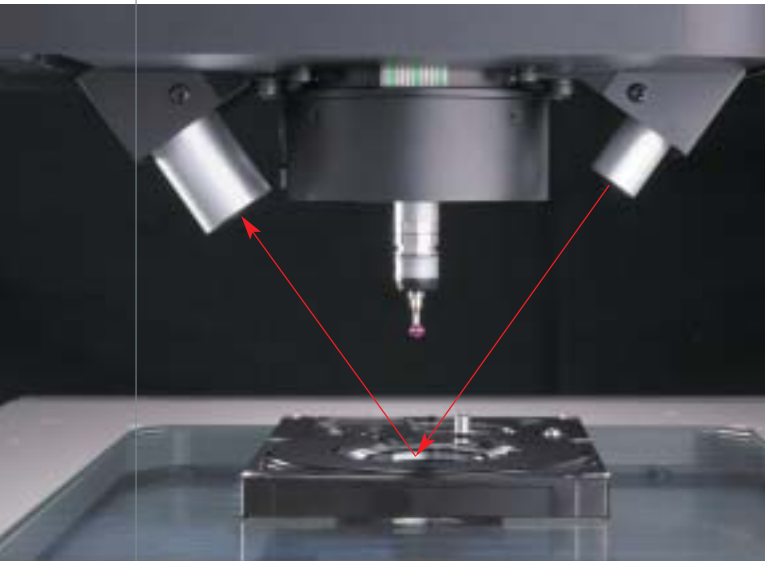

High-speed, high-precision Vision AF

Thanks to the adoption of a new algorithm and a progressive scan CCD camera, Vision AF now provides greater speeds and accuracy. Vision AF is convenient for applications such as focusing surface and edges of a workpiece.

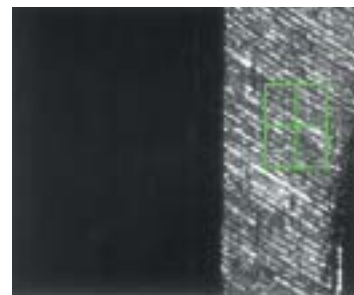

Surface focus



Contrast focus

Optically independent Laser AF (option)

As well as the standard Vision AF, fast Laser AF that features a long 63mm working distance can be used as an option. The Laser AF for the VMA-2520 employs a non-contact sensor that uses a red semiconductor laser light as a fill light, and enables height detection with sub-micrometer resolution. The Laser AF provides fast and precise focusing on workpiece surfaces regardless of optical magnification, making measuring the height of workpieces easier.

Touch probe for height and side measurements (option)*

The iNEXIV VMA-2520 accepts the Renishaw® TP20 or TP200 touch-trigger probing system, making contact-probing measurements possible. It detects surface and side coordinates for complicated 3D parts, where vision sensing can not be used.

*Touch probe option will be available in summer 2007.
Renishaw® is a registered trademark of Renishaw plc.



Renishaw® Probe Head with TP20 touch trigger probing system

Nikon's advanced image processing algorithm

In combination with Nikon's new image processing technology, the VMA-2520 provides state-of-the-art image processing technology. The digital video image outputs are transferred to a PC's IEEE1394 port via the controller and processed for sub-pixel level edge detection. This eliminates the need for a frame grabber in the host computer and enables high-speed, highly-accurate observations and measurements. The 3CCD progressive scan color camera also achieves FOV measurement repeatability equivalent to that of a monochrome camera.

Video edge probes with auto "best-fit" function

When the operator clicks the point to be measured, the system automatically rotates the probes, sets them at the optimum position, and sets the probe size, all automatically.



Drag to resize and fit the projection probe to the edge

After this process

Easy selection of desired edges by eliminating dust and burrs

Some workpieces contain multiple edges within a given caliper, or their contrast is too low, making edge detection extremely difficult. This function graphically profiles the contrasts of the image within the caliper using a multi-gray-level scale, enabling the operator to select any one of a number of edges. Selection of the desired edge is simple: click the appropriate buttons in the edge selection menu and adjust the threshold level using the mouse.

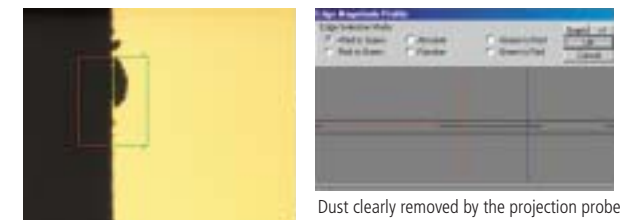

Gray scale processing

Dust clearly removed by the projection probe
Edge selection graphic window

Advanced intelligent search

Skew alignment and deviations between the edge probing points within a workpiece are automatically corrected by a pattern-matching feature, eliminating possible measurement errors.

APS (Auto Position Search)

Thanks to this function, the operator no longer needs to manually place multiple workpieces in proper alignment; the iNEXIV automatically searches workpiece position for skew alignment.

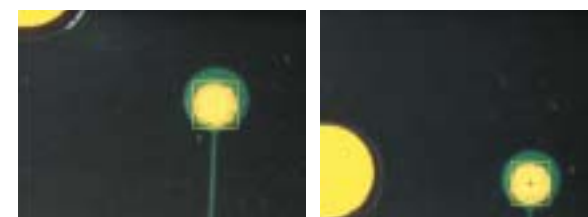

Search on left-side mark

Search on right-side mark



Before APS



After APS

MPS (Multi-Pattern Search)

Automatically corrects deviations between the edge probing points programmed in a teaching file as well as irregular feature positions without edge probing error.



Normal pin location



Pattern matched on abnormal pin location



Circle probe appears on the abnormal pin location without measurement failure

User-friendly standard software iNEXIV VMA AutoMeasure

Main program layout

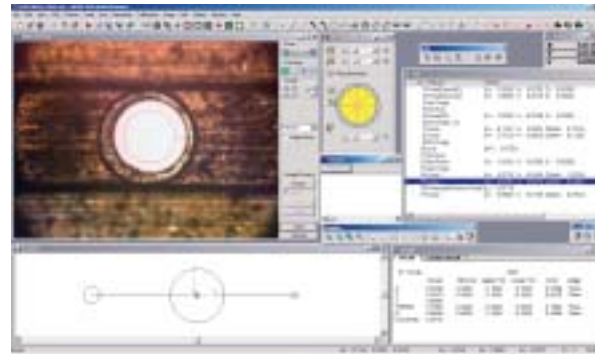

The VMA AutoMeasure software provides enhanced ease of use and versatility because it is based on years of extensive experience with the NEXIV VMR series. An intuitive wizard menu and operation window with large icons can be customized by selecting engineering mode or operator mode. A specified GUI environment can be stored with an individual ID using the ID registration function. User teach files (parts measurement programs) can now be stored with notes and images for easy recognition and recall. Even the number of mouse clicks required for each operation has been reduced to simplify and speed up the measurement process. Also, iNEXIV VMA AutoMeasure supports a multiple-language environment. The software can switch languages without having to restart the program.

iNEXIV mode switcher to select proper operation procedures



Selection of a teaching file with interactive guides



Measurement wizards

Interactive measurement wizards

The measurement wizards guide operators, step by step, through what is required to achieve their tasks. In addition to the default wizards, operators can create customized wizards by registering frequently used procedures to streamline future operation.

Online CAD interface program

By importing a workpiece's CAD data in, for example, DXF format, the operator can display graphics in the CAD graphic window on iNEXIV VMA AutoMeasure. This facilitates efficiency in teaching and shortens working time. The operator can move the stage to the desired position by double-clicking the appropriate position within the input workpiece. Also, it is possible to create a teaching file automatically from CAD feature data on iNEXIV VMA AutoMeasure.

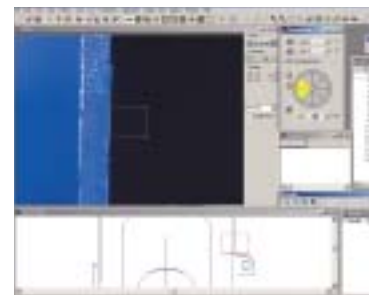

Handy optional hardware & software Time and labor reduction throughout the work process



EDF (Extended Depth of Field)



2D image stitching

Imaging Documentation Program: NEXIV EDF/Stitching Express

This optional software makes EDF—Extended Depth of Field—images by extracting focused pixel information from multiple captured images in Z-axis direction. Also, it generates 2D stitching images from different FOV images captured with CNC XY stage motion, making a wide FOV observation possible. Both functions contribute to image documentation.

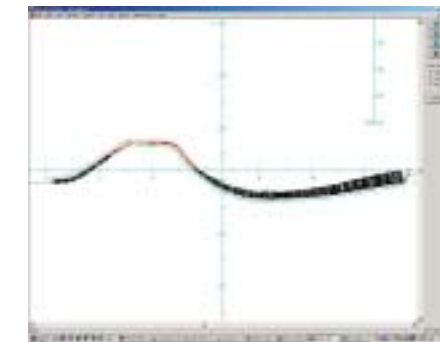

Two-dimensional profile shape analysis program: iNEXIV VMA Profiler/CAD Reader

iNEXIV VMA Profiler makes it possible to measure and judge 2-dimensional profile shapes in a workpiece that cannot be measured in the normal geometric mode. Now more accurate quantitative measurements can be taken than with the chart comparison method using profile projectors and/or conventional measuring microscopes. With the iNEXIV VMA CAD Reader nominal shape data can be created from CAD data in the DXF/IGES file format.

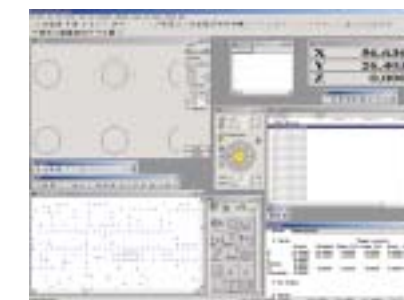

CAD interface off-line teaching support program: iNEXIV VMA Virtual AutoMeasure

This program enables CAD data to be read into the Virtual Video Window on a separate computer, allowing the operator to use iNEXIV's teaching program with the same operational procedures as on the online computer. This eliminates the necessity of using an actual workpiece during teaching sessions and lets the iNEXIV VMA system concentrate on automatic measurement for increased productivity. The software imports IGES, DXF, DMIS, NC files, Gerber, and so on.

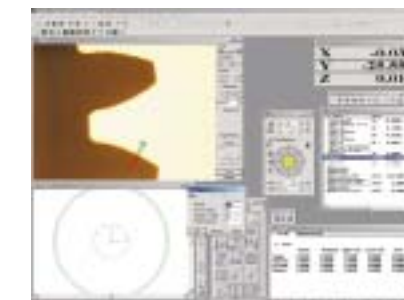

Gear evaluation software

This software provides evaluations on various parameters of a measured workpiece, including pitch deviations, tooth space runoff, base tangent length, and dimension overpin, based on industrial standards.



Report generating program: VMR Report Generator

This software enables quick generation of inspection result sheets in various report forms including user-designed forms. Users can even customize the program by creating macro scripts to meet any special requirements.

Operating environment: Windows® 2000/XP
 Microsoft Excel® 2000 or later
 Required memory: 128MB (min)
 Codevelopment: Pronics Co., Ltd.



Report and chart generating program: Custom Fit QC

Suitable for lot control of inspection data such as maximum value, minimum value, range, standard deviation and process capability index.

- In addition to 10 standard inspection result sheet forms, it is possible to customize original forms.
- BMP and JPEG files can be pasted onto the inspection result sheet.
- Automatic generation of graph and changeable degree/minute/second display.
- Easy to generate histograms, X-R control charts and scatter diagrams.

Operating environment: Windows® 2000/XP
 Microsoft Excel® 2000 or later
 Required memory: 128MB (min)
 Codevelopment: Aria Co., Ltd.



Real-time SPC via DDE (Dynamic Data Exchange)

Using a DDE Link function, measured data can be immediately transferred to spreadsheets such as Microsoft Excel®, SPC-PC IV, SPC-PC IV Excel, and others, making real-time SPC analysis possible.

Note: SPC-PC IV and SPC-PC IV Excel are products of Quality America Inc.

Nikon rotary indexer RI-3600L

The RI-3600L can rotate the image of a workpiece and display it with a 0.01° resolution. Because it can be controlled externally, it enables automatic measurements while controlling the posture of the workpiece.

Minimum readout: 1"
 Control resolution: 0.01°
 Max. workpiece diameter: 75mm
 Operation mode: Auto or Manual
 Pre-set points: Point of origin and 3 others



Top View of Stage

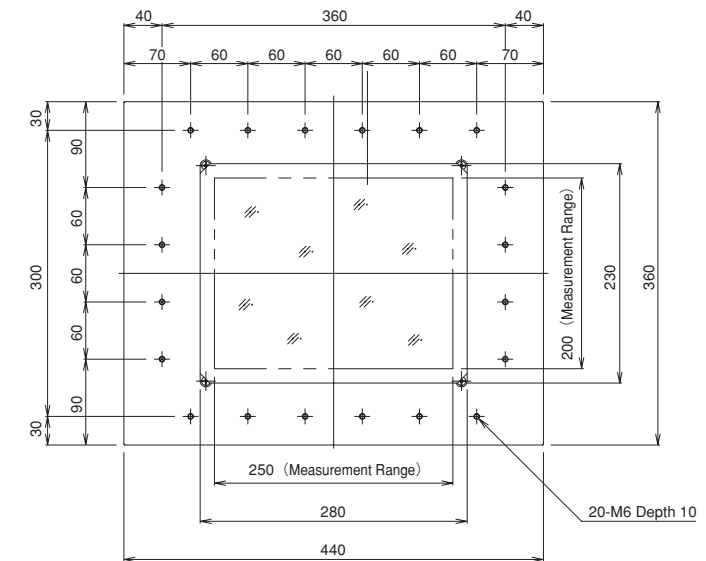

Dimensional diagram

Unit: mm

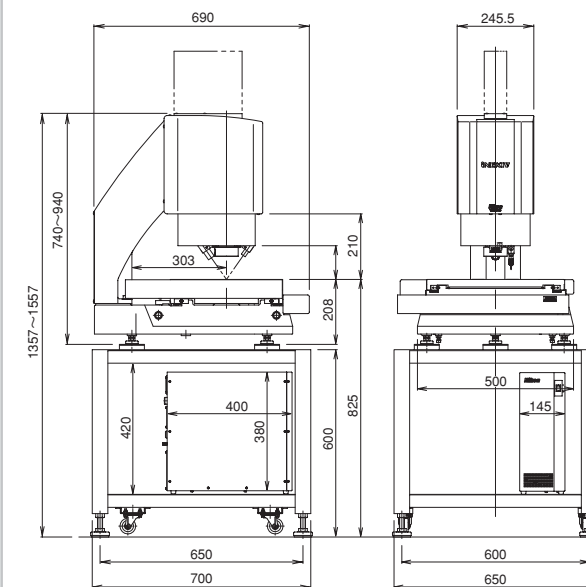

Specifications

iNEXIV VMA-2520 main body	
Stroke (X x Y x Z)	250 x 200 x 200mm (10" x 8" x 8")
Minimum readout	0.1μm
Maximum workpiece weight	15kg (up to 5kg accuracy guaranteed)
MPE*	XY MPEE1: 2+8L/1000μm XY MPEE2: 3+8L/1000μm Z MPEE1: 3+L/50μm
Camera	1/3-in. 3CCD color Progressive scan (B/W optional)
Working distance	73.5mm (63mm with LAF)
Magnification	Optical: 0.35 to 3.5x On screen: 12 to 120x (with 17" monitor at SXGA resolution)
FOV size	13.3 x 10 to 1.33 x 1mm
Auto focus	Vision AF and optional Laser AF
Illumination	Contour illumination: White LED illumination Surface illumination: White LED illumination Oblique illumination: 8-segment white LED ring
Video resolution	640 x 480 (pixels)
Touch probe	Renishaw® TP200/TP20 (option)
Power source	100V-240V, 50/60Hz
Power consumption	5A-2.5A (excluding power consumption of host computer and its peripherals)
Dimensions & weight	Main body (W x D x H): 565 x 690 x 740mm (minimum height), 72kg Controller: 145 x 400 x 390mm, 13kg Table for main body (option): 600 x 700 x 825mm, 38kg
Recommended workbench	Min. load capacity 1000kg or more
Host computer	
CPU	Intel Core Duo 1.8GHz or faster
Memory	1G or more
Operating system	Windows® XP Pro SP2 or later
Interface	USB2.0/IEEE1394

*Nikon's in-house test

Laser AF is a Class 1 Laser Product

CLASS 1 LASER PRODUCT

Specifications and equipment are subject to change without any notice or obligation on the part of the manufacturer. December 2006 ©2006 NIKON CORPORATION

 **WARNING** TO ENSURE CORRECT USAGE, READ THE CORRESPONDING MANUALS CAREFULLY BEFORE USING YOUR EQUIPMENT.

* Monitor images are simulated.
Company names and product names appearing in this brochure are their registered trademarks or trademarks.



ISO 9001 Certified
NIKON CORPORATION
Instruments Company



ISO 14001 Certified
NIKON CORPORATION
Yokohama Plant



NIKON CORPORATION
Parale Mitsui Bldg., 8, Higashida-cho, Kawasaki-ku,
Kawasaki, Kanagawa 210-0005, Japan
phone: +81-44-223-2175 fax: +81-44-223-2182
<http://www.nikon-instruments.jp/eng/>

NIKON INSTRUMENTS INC.
1300 Walt Whitman Road, Melville, N.Y. 11747-3064, U.S.A.
phone: +1-631-547-8500; +1-800-52-NIKON (within the U.S.A. only)
fax: +1-631-547-0306
<http://www.nikonusa.com/>

NIKON INSTRUMENTS EUROPE B.V.
P.O. Box 222, 1170 AE Badhoevedorp, The Netherlands
phone: +31-20-44-96-222 fax: +31-20-44-96-298
<http://www.nikon-instruments.com/>

NIKON INSTRUMENTS (SHANGHAI) CO., LTD.
CHINA phone: +86-21-5836-0050 fax: +86-21-5836-0030
(Beijing office) phone: +86-10-5869-2255 fax: +86-10-5869-2277
(Guangzhou office) phone: +86-20-3882-0552 fax: +86-20-3882-0580

NIKON SINGAPORE PTE LTD
SINGAPORE phone: +65-6559-3618 fax: +65-6559-3668

NIKON MALAYSIA SDN. BHD.
MALAYSIA phone: +60-3-78763887 fax: +60-3-78763387

NIKON INSTRUMENTS KOREA CO., LTD.
KOREA phone: +82-2-2186-8410 fax: +82-2-555-4415

NIKON CANADA INC.
CANADA phone: +1-905-625-9910 fax: +1-905-625-0103

NIKON FRANCE S.A.S.
FRANCE phone: +33-1-45-16-45-16 fax: +33-1-45-16-00-33

NIKON GMBH
GERMANY phone: +49-211-9414-0 fax: +49-211-9414-322

NIKON INSTRUMENTS S.p.A.
ITALY phone: +39-55-3009601 fax: +39-55-300993

NIKON AG
SWITZERLAND phone: +41-43-277-2860 fax: +41-43-277-2861

NIKON UK LTD.
UNITED KINGDOM phone: +44-20-8541-4440 fax: +44-20-8541-4584

NIKON GMBH AUSTRIA
AUSTRIA phone: +43-1-972-6111-00 fax: +43-1-972-6111-40

NIKON BELUX
BELGIUM phone: +32-2-705-56-65 fax: +32-2-726-66-45

